

901817

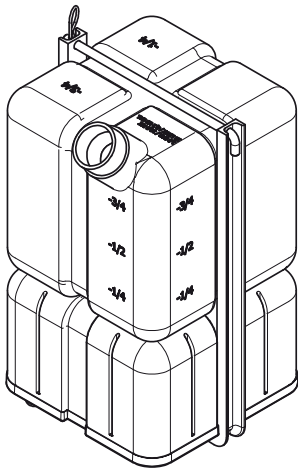

901813.03

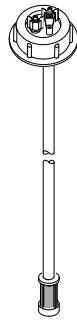

800024.02

901841

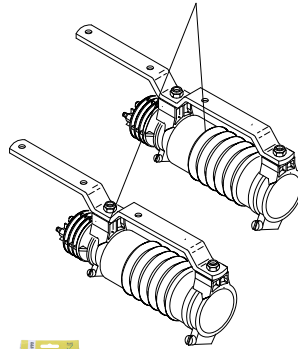

BL-400504



BL-901268

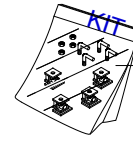

901674

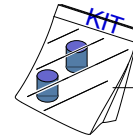

901649



901736

901705

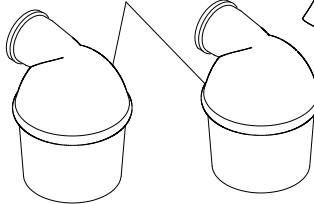

901762



IST056

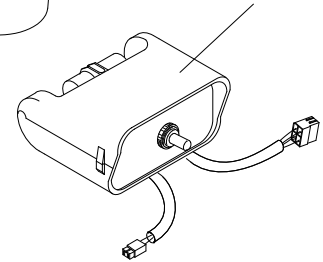

2x 901647 = 16 mt. 6/6

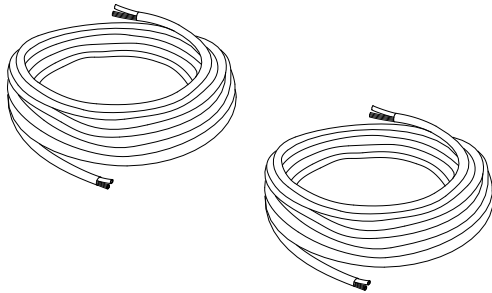

PACKING

700065

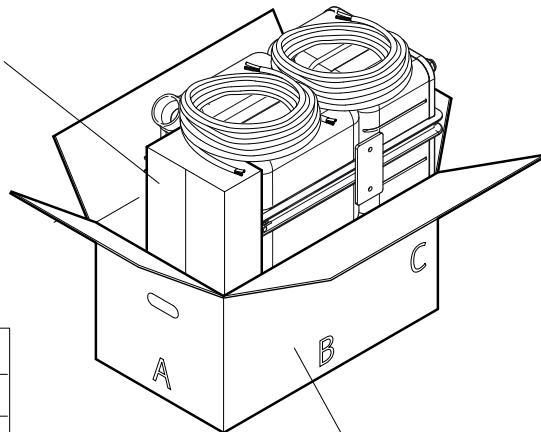

700070

901703 = mt.2

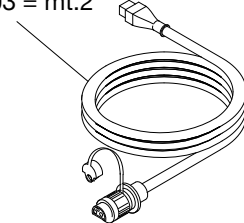

901512 = mt.5

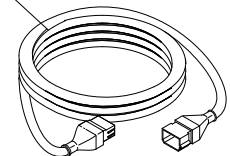

	AxBxC	30 x 60 x 39
	netto	Kg.
	lordo	Kg. 15
		m ³ 0,070

Data	Modifica	Nome	Data	Modifica	Nome
10/11/2017	Aggiunto adesivo ET115, schiumogeno 500018 e 905049 diventa BL-400504	PG			
23/03/2022	Tolto adesivo ET115 e schiumogeno 500018	PG			

Salvarani

FOAM MARKER COMPACT
SPRUZZATORE ORIZZONTALE

Cod. rif.:

Cod. 901840

CARTELLA - S.I. TRACCIAFILE

Data: 09/06/2017

QUESTO DISEGNO E' DI NOSTRA PROPRIETA', PERTANTO SENZA NOSTRA AUTORIZZAZIONE NE E' VIETATA LA RIPRODUZIONE E LA COMUNICAZIONE A TERZI, IN TERMINI DI LEGGE.
THIS DRAWING IS OF OUR OWNERSHIP, THEREFORE WITHOUT OUR AUTHORIZATION THE REPRODUCTION AND THE COMMUNICATION TO THIRDS PARTY ARE PROHIBITED, IN TERMS OF LAW.